



N-Channel Enhancement Mode Power MOSFET

R_Y12N65

MAIN CHARACTERISTICS

I_D	12A
V_{DSS}	650V
$R_{DS(on)-max}$ (@ $V_{GS}=10V$)	0.78 Ω
Q_G -typ	40nC

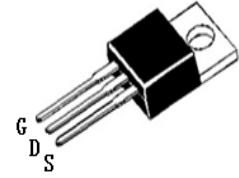
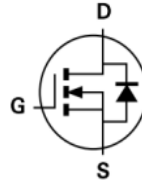

RYF12N65C/T0-220C

FEATURES

- Fast Switching
- Low ON Resistance
- Low Gate Charge
- 100% Single Pulse avalanche energy Test

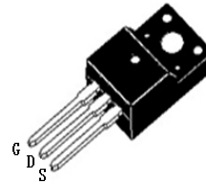

RYF12N65F/T0-220F

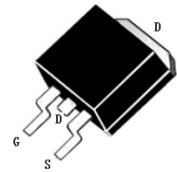

RY12N65A3/T0-263

APPLICATIONS

- Power switch circuit of adaptor and charger.

MECHANICAL DATA

- Case: Molded plastic
- Mounting Position: Any
- Molded Plastic: UL Flammability Classification Rating 94V-0
- Lead free in compliance with EU RoHS 2011/65/EU directive
- Solder bath temperature 275 $^{\circ}$ C maximum, 10s per JESD 22-B106

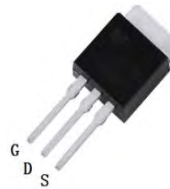

RY12N65A1/T0-251



RY12N65A2/T0-252

Marking on the body



MAKING:

X X X X X X

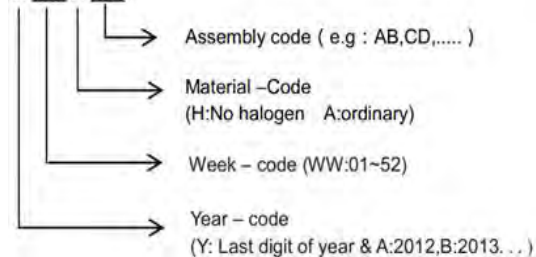

Ordering information

Part Number	Package	Unit Weight	Base Quantity	Delivery mode
RYF12N65F	TO-220C	0.07oz(1.96g)	50 pcs / tube	1Kpcs/box 5Kpcs/carton
RYF12N65F	TO-220F	0.06oz(1.74g)	50 pcs / tube	1Kpcs/box 5Kpcs/carton
RY12N65A3	TO-263	0.04oz(1.16g)	50 pcs / tube	1Kpcs/box 5Kpcs/carton
RY12N65A3	TO-263	0.04oz(1.16g)	800 pcs / reel	800pcs/box 4Kpcs/carton
RY12N65A1	TO-251	--	--	--
RY12N65A2	TO-252	0.011oz(0.32g)	2500 pcs / reel	2.5Kpcs/box 12.5Kpcs/carton



N-Channel Enhancement Mode Power MOSFET

RY12N65

Maximum Ratings at Tc=25°C unless otherwise specified

Characteristics	Symbol	Value			Unit
		220C/263	220F	251/252	
Drain-Source Voltage	V_{DS}	650			V
Gate-Source Voltage	V_{GS}	±30			V
Continue Drain Current	I_D	12			A
Pulsed Drain Current (Note1)	I_{DM}	48			A
Power Dissipation	P_D	210	51	178	W
Single Pulse Avalanche Energy (Note1)	E_{AS}	550			mJ
Operating Temperature Range	T_J	150			°C
Storage Temperature Range	T_{STG}	-55 to +150			°C
Thermal Resistance, Junction to Case	$R_{\theta JC}$	0.83	2.98	1.04	°C/W
Thermal Resistance, Junction to Ambient	$R_{\theta JA}$	62.5	62.5	100	°C/W

Note1:Pulse test: 300 μs pulse width, 2 % duty cycle

Electrical Characteristics at Tc=25°C unless otherwise specified

Characteristics	Test Condition	Symbol	Min	Typ	Max	Unit
Drain-Source Breakdown Voltage	$V_{GS} = 0 V, I_D = 250 \mu A$	BV_{DSS}	650	-	-	V
Drain-Source Leakage Current	$V_{DS} = 650 V, V_{GS} = 0 V$	I_{DSS}	-	-	1	μA
Gate Leakage Current	$V_{GS} = \pm 30 V, V_{DS} = 0 V$	I_{GSS}	-	-	±100	nA
Gate-Source Threshold Voltage	$V_{DS} = V_{GS}, I_D = 250 \mu A$	$V_{GS(th)}$	2	-	4	V
Drain-Source On-State Resistance	$V_{GS} = 10 V, I_D = 6 A$	$R_{DS(on)}$	-	-	0.78	Ω
Forward Transconductance	$V_{DS} = 15 V, I_D = 6 A$	g_{fs}	-	12	-	S
Input Capacitance	$V_{GS} = 0 V, V_{DS} = 25 V, f = 1 MHz$	C_{iss}	-	2000	-	pF
Output Capacitance		C_{oss}	-	160	-	pF
Reverse Transfer Capacitance		C_{rss}	-	10	-	pF
Turn-on Delay Time(Note2)	$I_D = 12 A, V_{DD} = 325V, R_G = 10 \Omega$	$t_{d(ON)}$	-	28	-	ns
Rise Time(Note2)		t_r	-	26	-	ns
Turn-Off Delay Time(Note2)		$t_{d(OFF)}$	-	64	-	ns
Fall Time(Note2)		t_f	-	45	-	ns
Total Gate Charge(Note2)	$I_D = 12 A, V_{DD} = 520 V, V_{GS} = 10 V$	Q_G	-	40	-	nC
Gate to Source Charge(Note2)		Q_{GS}	-	10	-	nC
Gate to Drain Charge(Note2)		Q_{GD}	-	14	-	nC

Source-Drain Diode Characteristics at Ta=25°C unless otherwise specified

Characteristics	Test Condition	Symbol	Min.	Typ.	Max.	Unit
Maximun Body-Diode Continuous Current		I_S	-	-	12	A
Maximun Body-Diode Pulsed		I_{SM}	-	-	48	A
Drain-Source Diode Forward Voltage	$I_{SD} = 12 A$	V_{SD}	-	-	1.4	V
Reverse Recovery Time(Note2)	$I_{SD} = 12 A, V_{GS} = 0 V, di_F / dt = 100 A/\mu s$	t_{rr}	-	650	-	ns
Reverse Recovery Charge(Note2)		Q_{rr}	-	4.3	-	μC

Note2:Pulse test: 300 μs pulse width, 2 % duty cycle



RY12N65

RATINGS AND CHARACTERISTIC CURVES

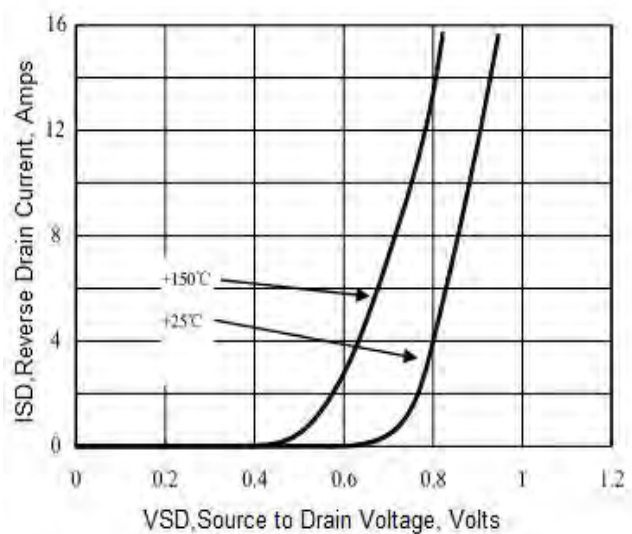
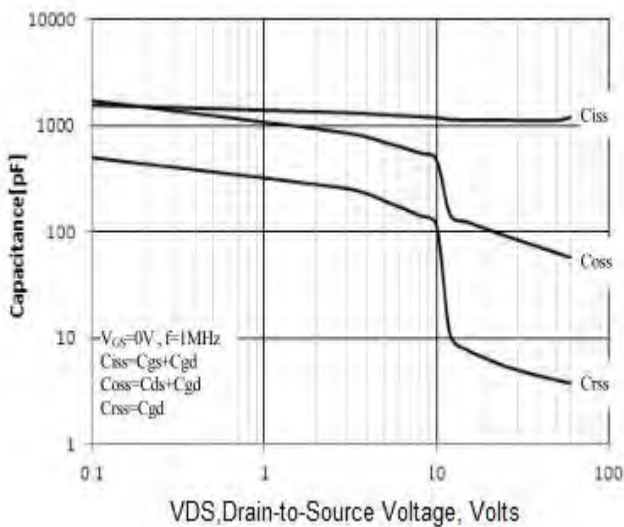
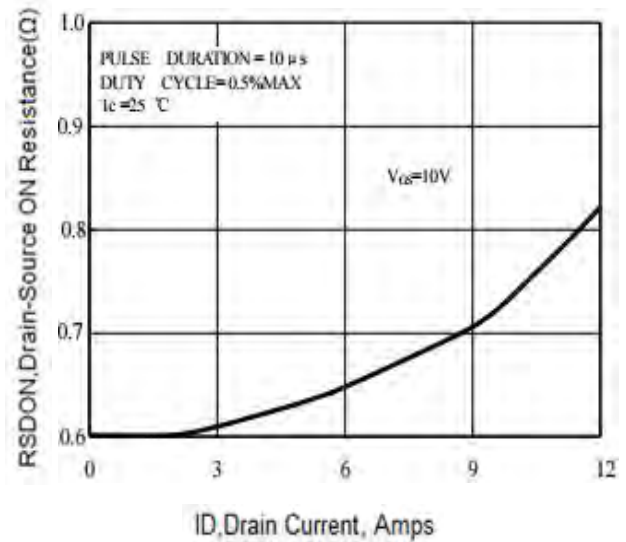
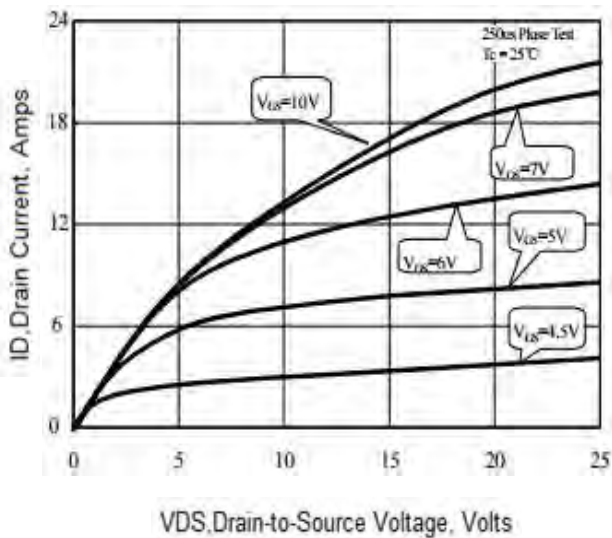
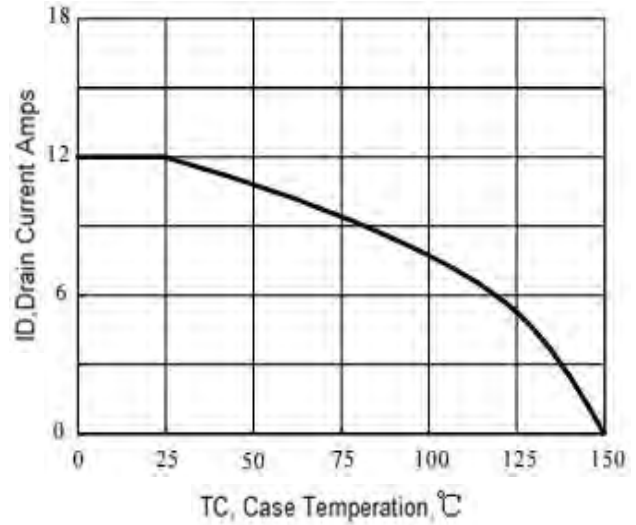
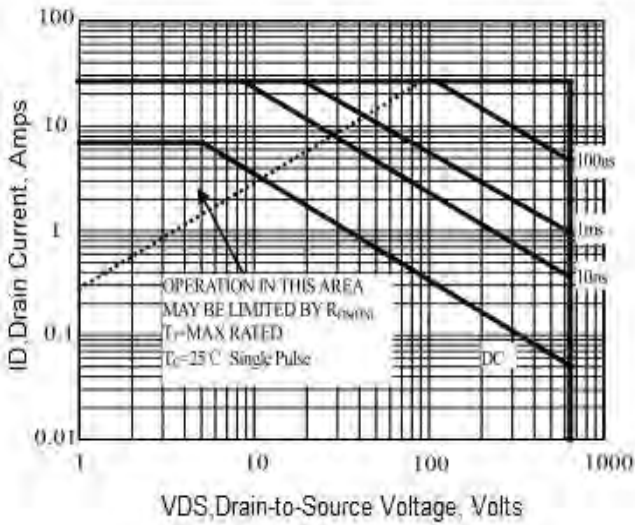

RY12N65

Package Outline Dimensions millimeters

TO-220AB

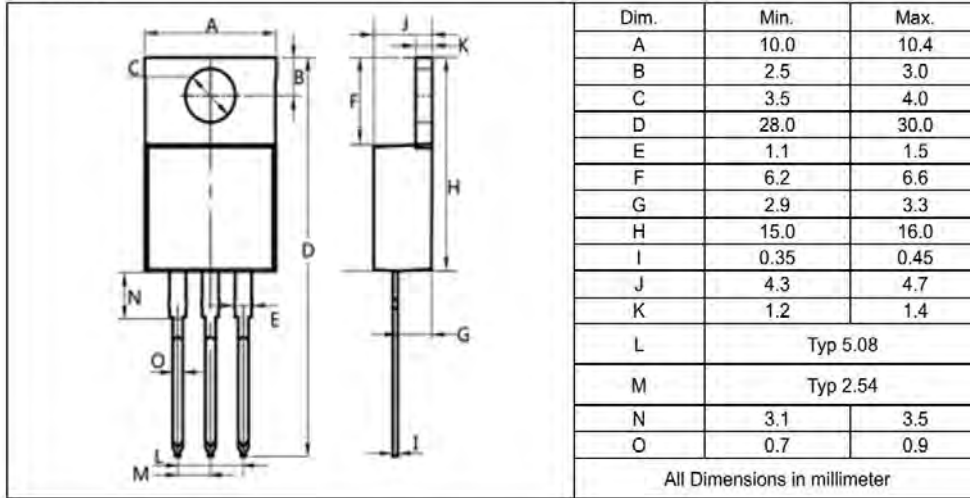

TO-220F

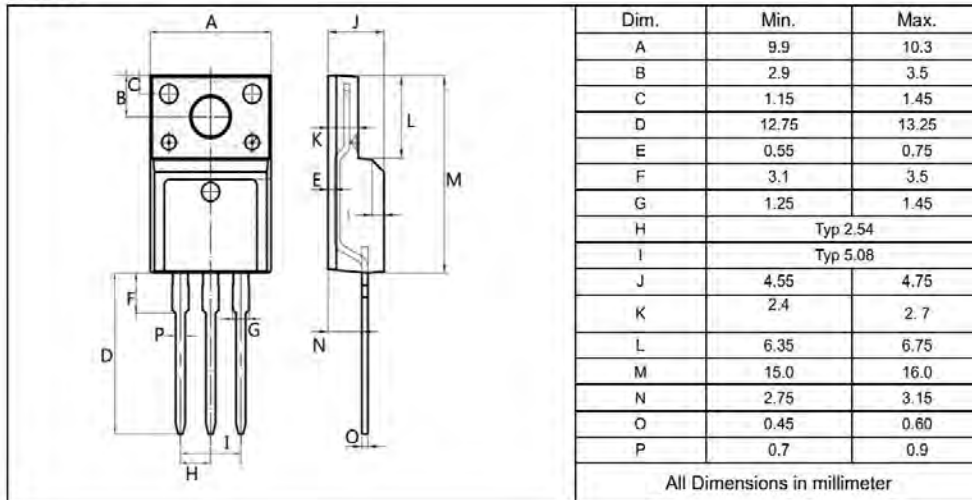

TO-263

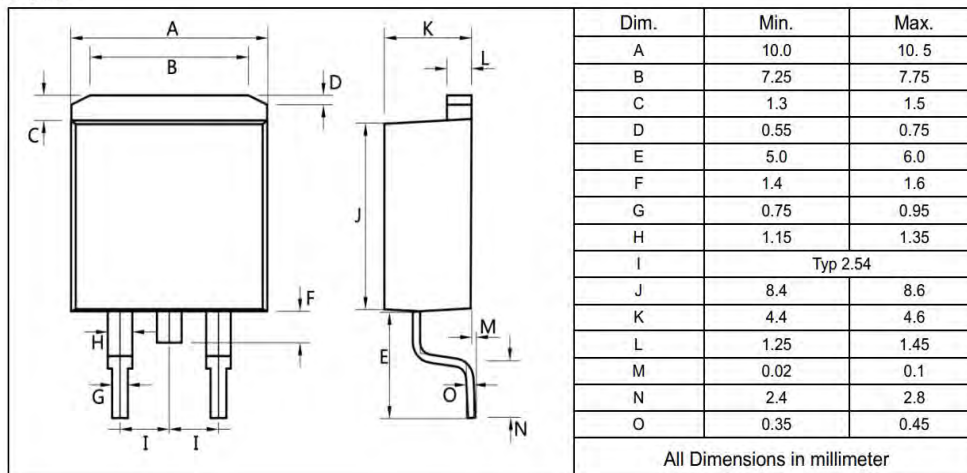

RY12N65

Package Outline Dimensions millimeters

TO-252

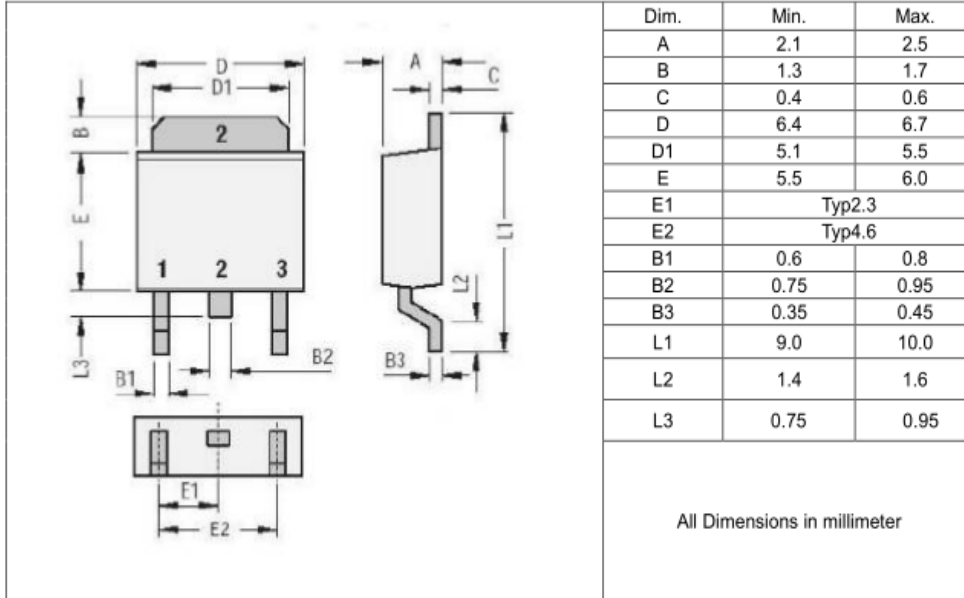

TO-251

